

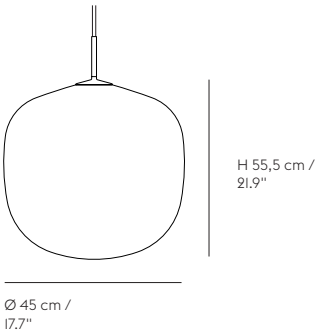

# RIME PENDANT LAMP – EU VERSION

**TAF STUDIO ON THE DESIGN** “Designing simple things is often one of the hardest things to do. We wanted to create a simple lamp with a glass shape, giving it a soft expression while making its top and pendant tube as subtle as possible. We were inspired by the shape of acorns for the gentle lines of the pendant while hinting towards the shaded expression of ice and rime for the glass of the design, allowing for the light to shine slightly through with a refined touch. The Rime Pendant Lamp brings a timeless yet modern perspective to the archetypal light through its translucent shade and graphic form.”

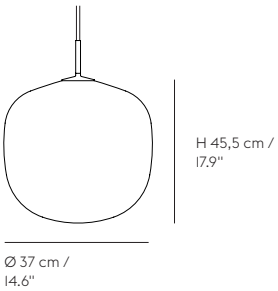
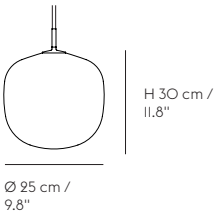
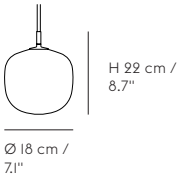
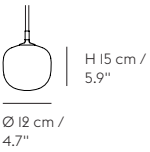

**READY-TO-SHIP OPTIONS**



**DESIGNED BY / YEAR OF DESIGN**

TAF Studio / 2020

**ABOUT THE DESIGNER**

TAF Studio is a Stockholm-based design and architecture studio, founded by Gabriella Gustafson and Mattias Ståhlbom. The duo works within product and interior design.

**CATEGORY**

Pendant lamp

**ENVIRONMENT**

Indoor

**COUNTRY OF PRODUCTION**

Poland

**DESCRIPTION**

The Rime Pendant Lamp brings an elegant perspective to the glass pendant lamp through its semi-transparent glass that has been sandblasted for a refined expression. The design features a characteristic form, inspired by the shape of acorns, complemented by its powder-coated top-part, pendant tube and cord in a matching color for a subtle touch. The design is available in five colors across five sizes, allowing you to use the design on its own or in linear formations or playful clusters for a modern chandelier.

**MATERIAL**

Mouth-blown glass shade that has been sandblasted. Aluminum, powder coated top-piece and pendant tube. PVC cord.

**CORD LENGTH**

400 cm / 131"

**BULB INCLUDED**

Ø12 & Ø18: Yes  
Ø25, Ø37, Ø45: No

**CEILING CAP INCLUDED**

Yes - white  
Ø12, Ø18 & Ø25: Ø 9 cm / 3.5" H 5,6 cm / 2.2"  
Ø37 & Ø45: Ø 11 cm / 4.3" H 3,5 cm / 1.4"

**DIMMABLE FUNCTION**

Yes, if dimmable bulb is used.

**CLEANING AND CARE**

Clean with a dry cloth. Always switch off electricity supply before cleaning.

**GLOVES FOR MOUNTING THE DESIGN**

The Rime Pendant Lamp is made in a unique semi-transparent glass that has been sandblasted. Included in the box with the Rime Pendant Lamp is a set of gloves that we recommend worn when mounting the design to care for the unique surface of the material. If the gloves are not worn when mounting the design, fingerprints might be seen on the surface of the design.



# RIME PENDANT LAMP - EU VERSION

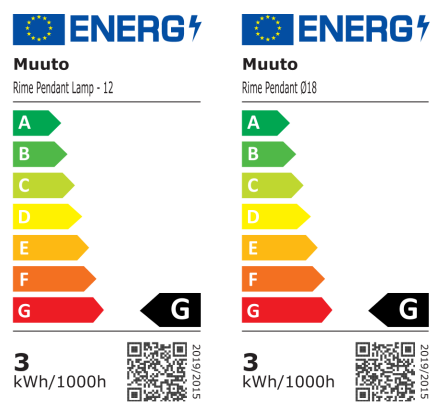
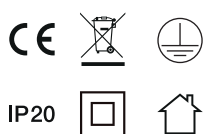

## LAMP RATING Ø12

Voltage	220 - 240V
Frequency	50/60Hz
IP Rating	IP20
Classification	Class II
Socket	1 x G9 Max. 25W

## BULB SPECIFICATION Ø12

Item	G9 LED
Watt	3 W
Lumen	200 lm
Kelvin	2700K
Lumen Maintenance	20.000h
CRI	90
Dimmable	Yes
Risk Group	Except

## LAMP RATING Ø18

Voltage	220 - 240V
Frequency	50/60Hz
IP Rating	IP20
Classification	Class II
Socket	1 x G9 Max. 25W

## BULB SPECIFICATION Ø18

Item	G9 LED
Watt	3 W
Lumen	200 lm
Kelvin	2700K
Lumen Maintenance	20.000h
CRI	90
Dimmable	Yes
Risk Group	Except

## LAMP RATING Ø25

Voltage	220 - 240V
Frequency	50/60Hz
IP Rating	IP20
Classification	Class II
Socket	1 x E14 Max. 40W

## BULB RECOMMENDATION Ø25

Lamp base	E14
Dimensions	Ø45 X 80 mm
Light source shape	P45
Recommended light output	400-800 lm (6-10 W LED)
Light source type	LED with opal or frosted

## LAMP RATING Ø37

Voltage	220 - 240V
Frequency	50/60Hz
IP Rating	IP20
Classification	Class I
Socket	1 x E27

## BULB RECOMMENDATION Ø37

Lamp base	E27
Dimensions	Ø60 X 110 mm
Light source shape	A60
Recommended light output	750-1500 lm (8-12 W LED)
Light source type	LED with opal or frosted

## LAMP RATING Ø45

Voltage	220 - 240V
Frequency	50/60Hz
IP Rating	IP20
Classification	Class I
Socket	1 x E27

## BULB RECOMMENDATION Ø45

Lamp base	E27
Dimensions	Ø77 X 145 mm
Light source shape	A67
Recommended light output	750-1500 lm (8-12 W LED)
Light source type	LED with opal or frosted diffuser



# RIME PENDANT LAMP - EU VERSION

## GENERAL STANDARDS & CERTIFICATES

### EU

REACH  
Directive - EC/1907/2006

ROHS Directive - 2011/65/EU amended RoHS 3 Directive 2015/863

ECO Design Directive - 245/2009/EC

WEEE Directive - 2012/19/EU

### AUS/NZL

RCM, EN 60598-1 and EN 60598-2-1 (AUS/NZ deviations)

### UK

BS EN 60598-1 and BS 4533-102.1, EN 60598-2-1

Electrical Equipment (Safety) Regulations 2016

Electromagnetic Compatibility Regulations 2016

The Restriction of the Use of Certain Hazardous Substances in Electrical and

Electronic Equipment Regulations 2012

The Ecodesign for Energy-Related Products and Energy Information

(Amendment) (EU Exit) Regulations 2019